

2004 NLTCS SCREENER INTERVIEW FLOWCHART

Key:

- Questionnaire varies from qcode
- Variable not in data file
- Not in data file, varies from qcode

Verification Module

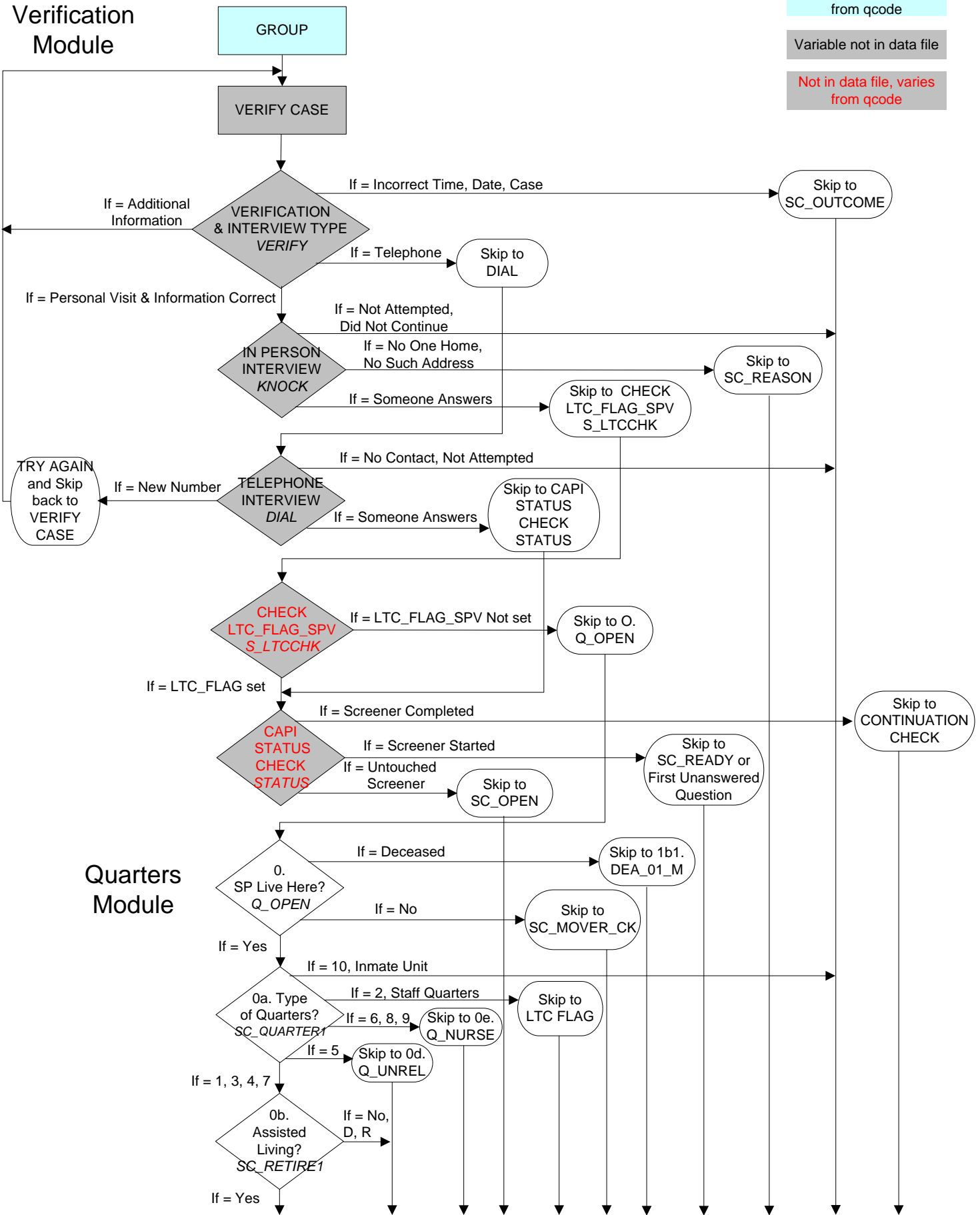

Quarters Module

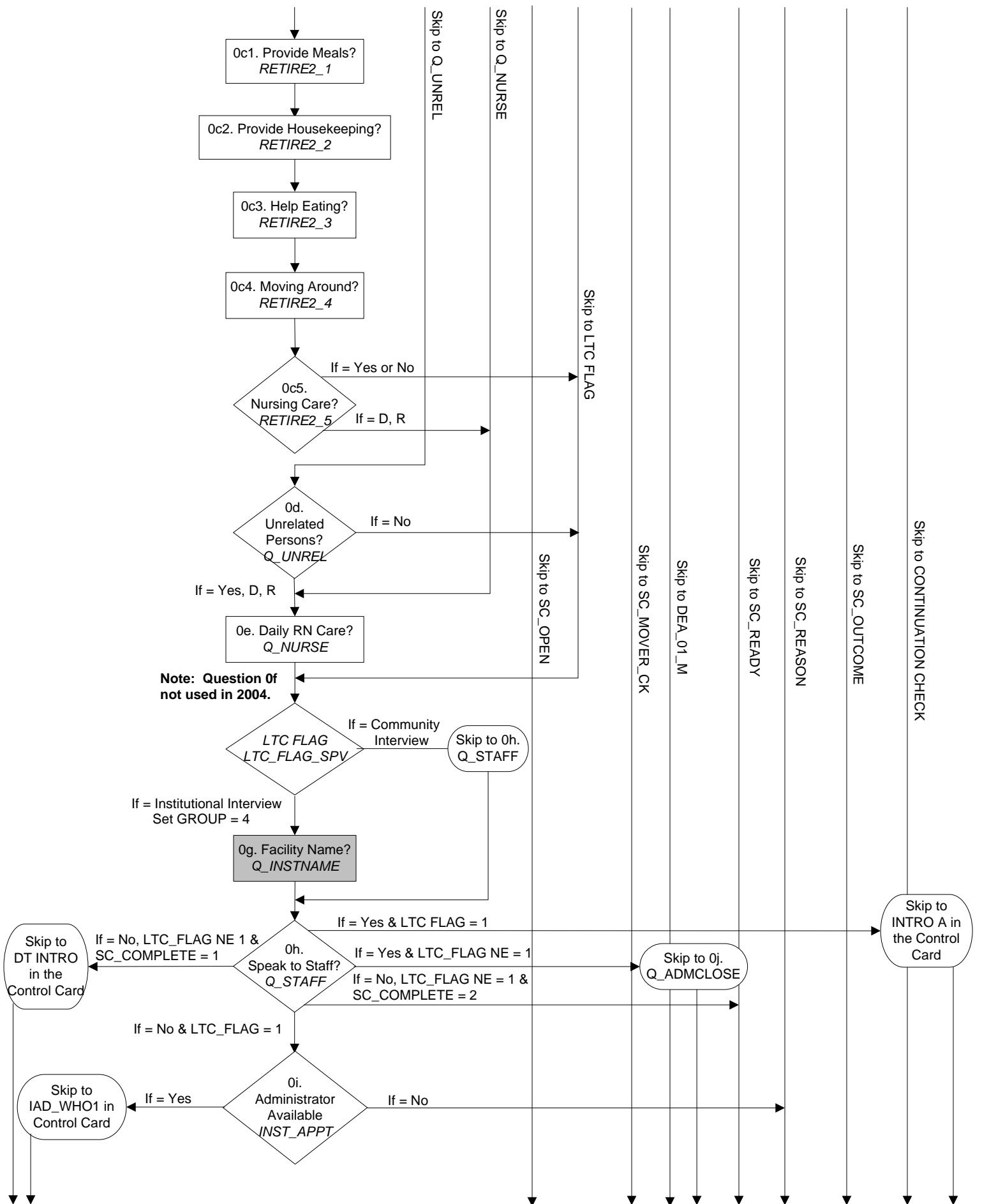

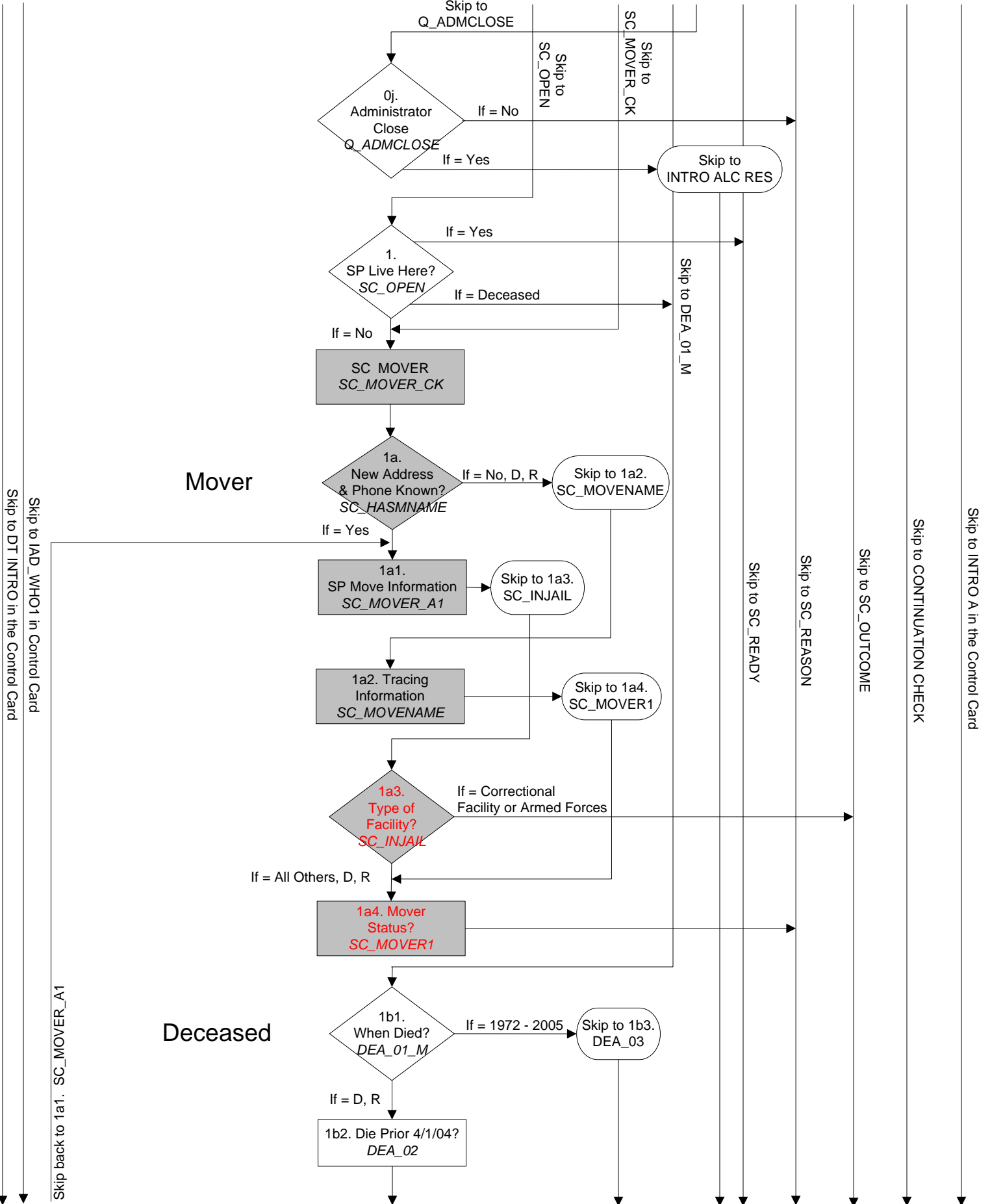

Mover

Deceased

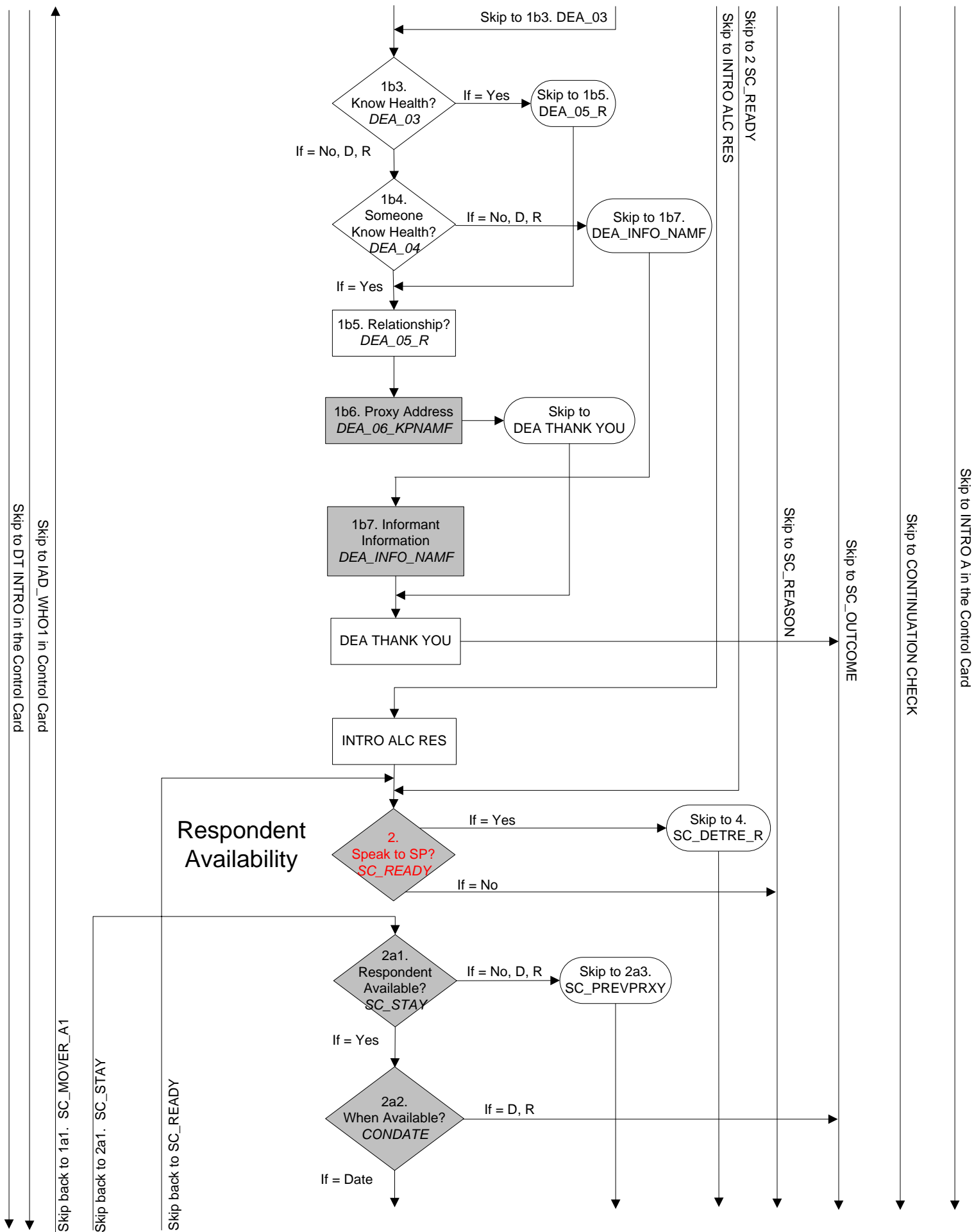

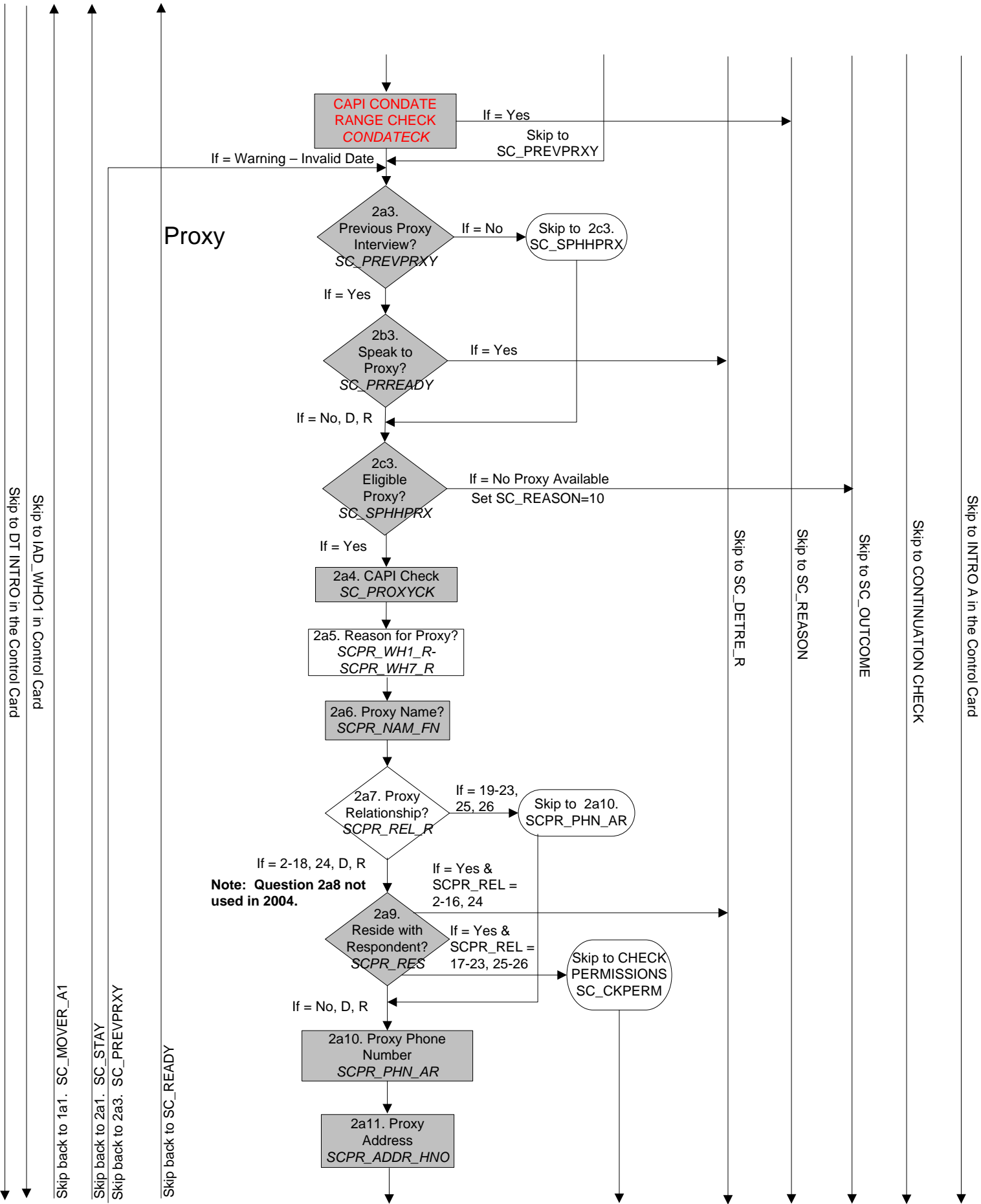

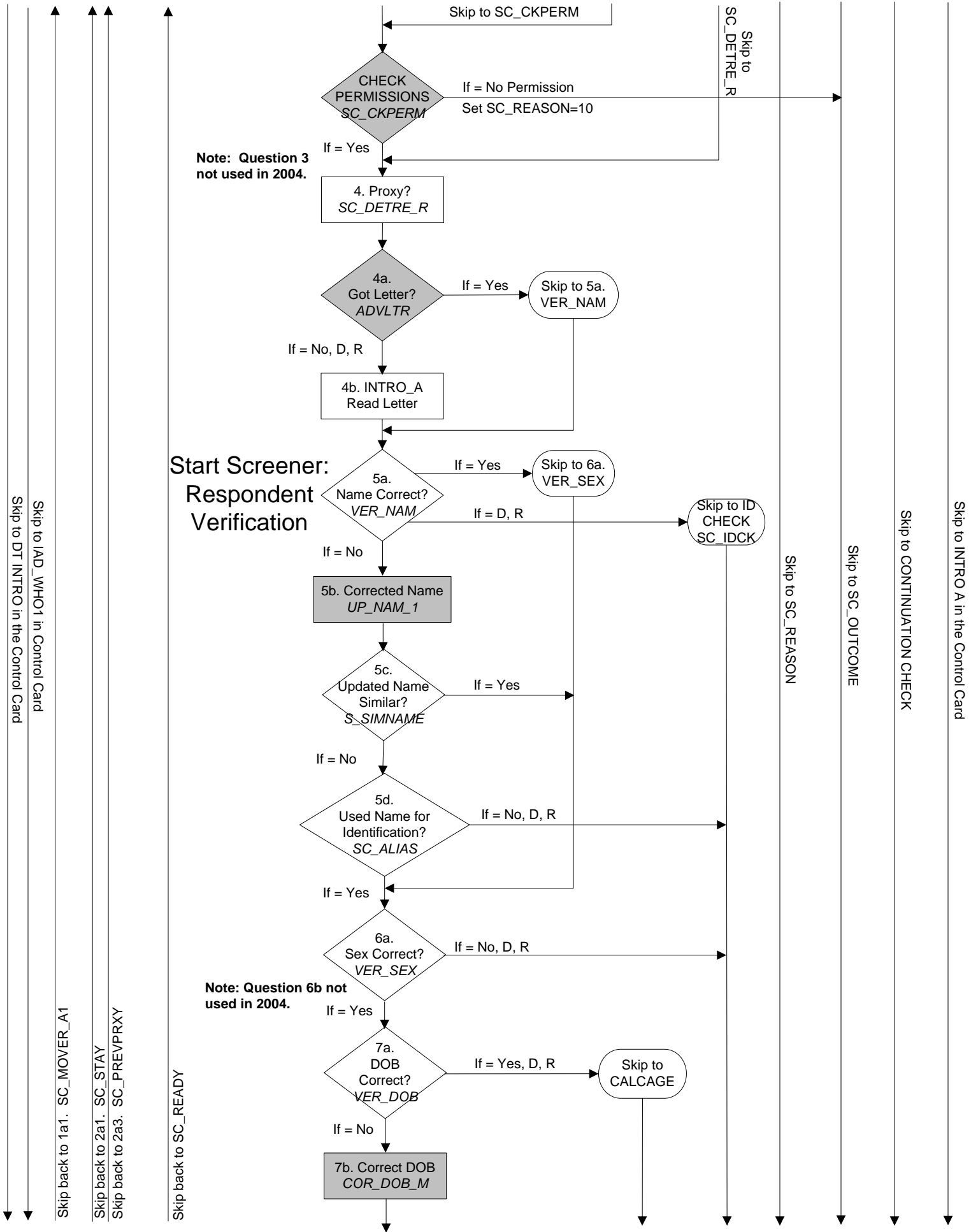

Note: Question 3 not used in 2004.

Start Screener:
Respondent
Verification

Note: Question 6b not used in 2004.

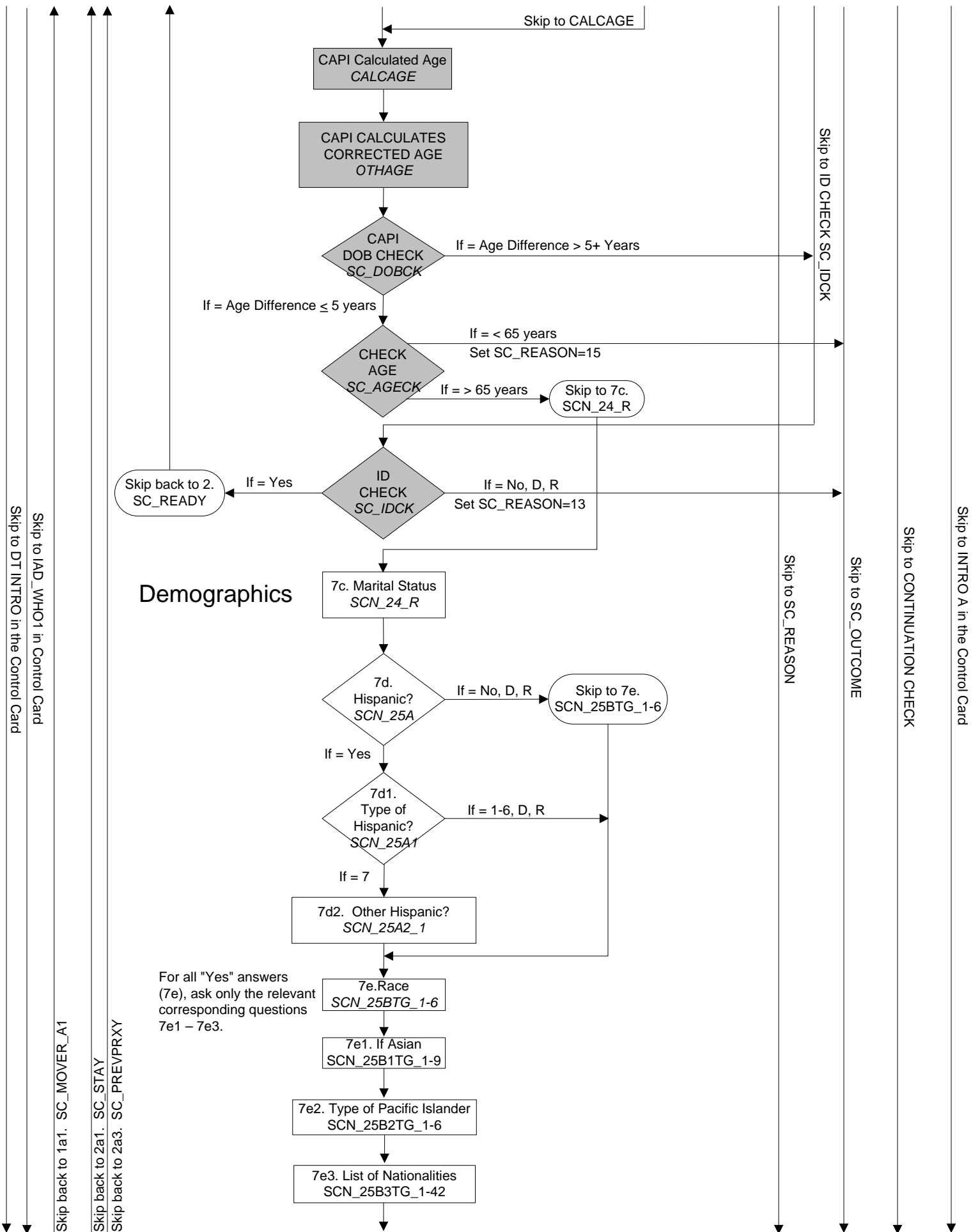

Military Experience

Tracing Information

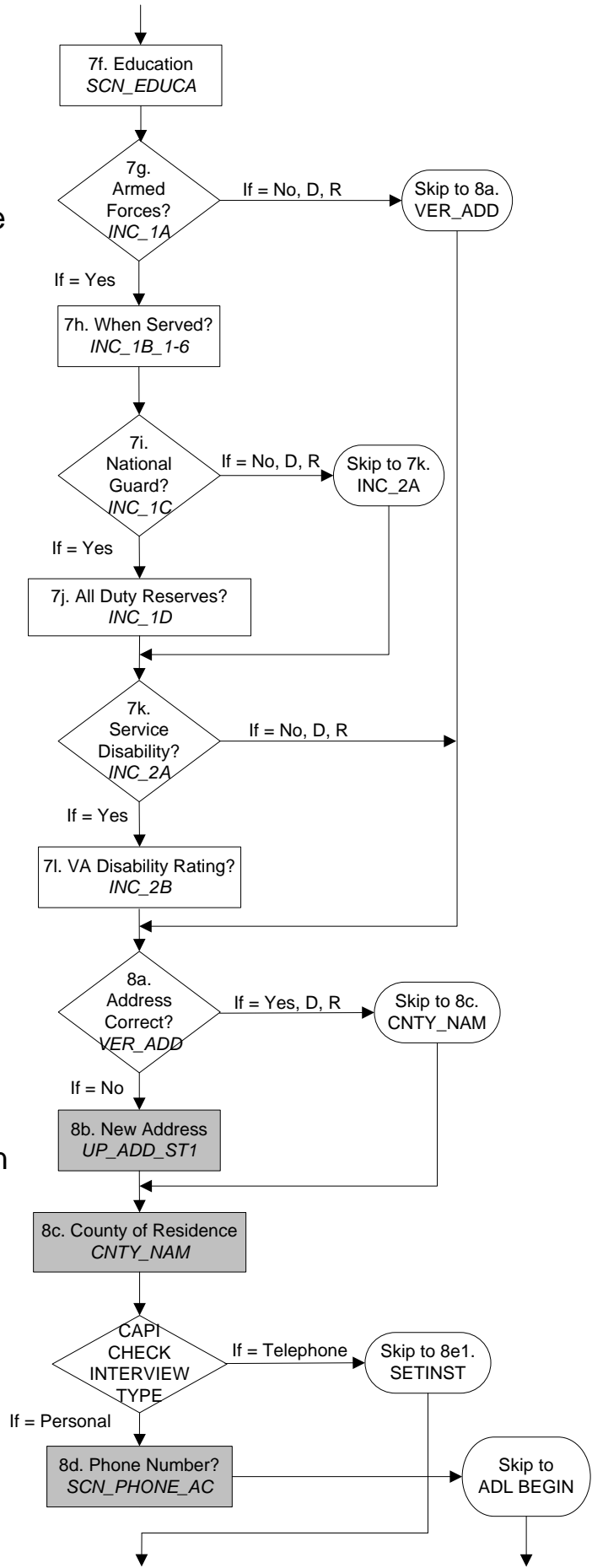

Skip to IAD_WHO1 in Control Card
Skip to DT INTRO in the Control Card

Skip to SC_REASON
Skip to SC_OUTCOME
Skip to CONTINUATION CHECK
Skip to INTRO A in the Control Card

Skip back to 1a1.
SC_MOVER_A1
Skip back to 2a1. SC_STAY
Skip back to 2a3.
SC_PREVPRXY

Telephone Interview
Institutional
Residential
Information

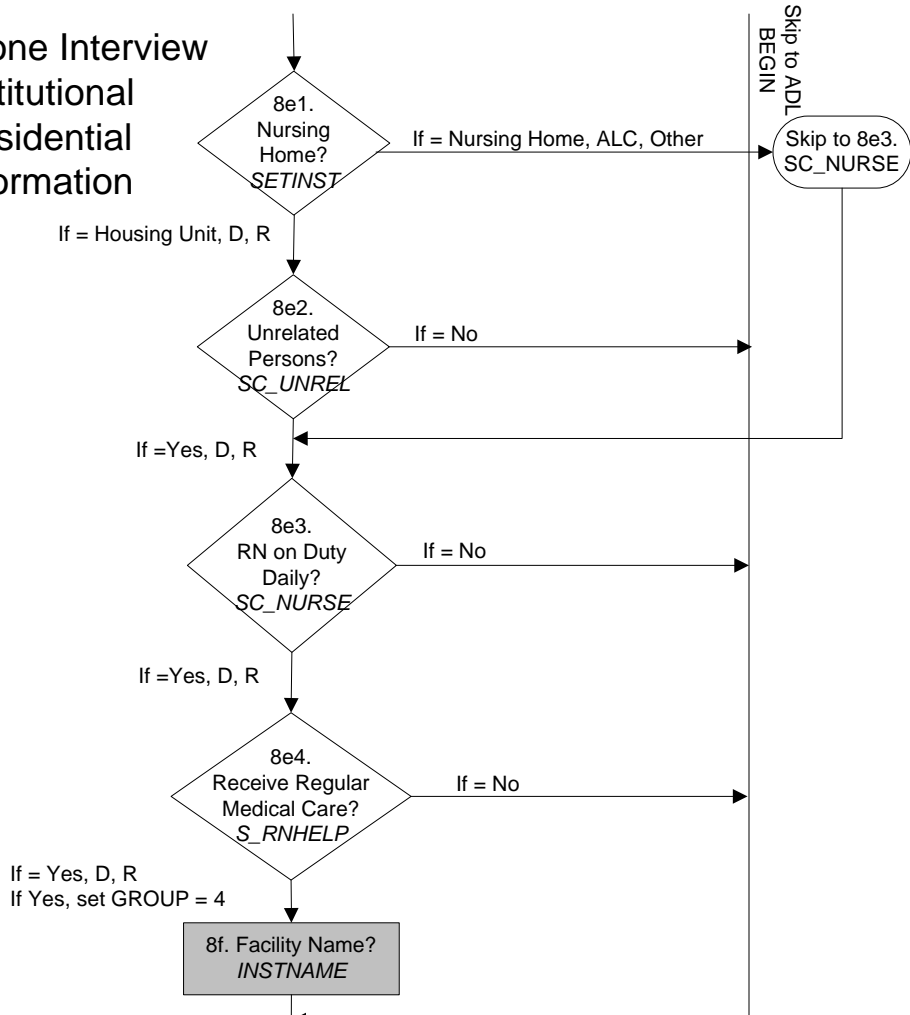

ADL
Module

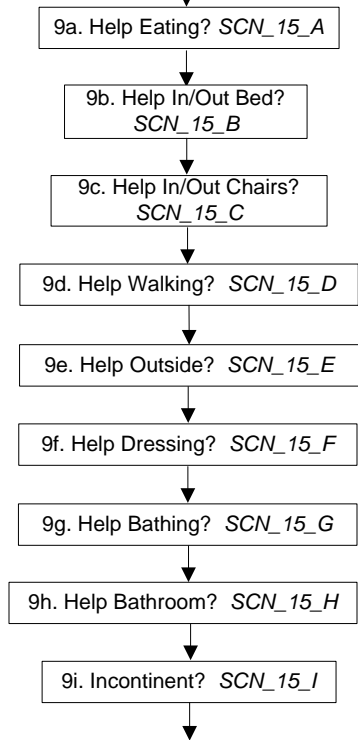

Skip to IAD_WHO1 in Control Card
Skip to DT INTRO in the Control Card

Skip back to 1a1. SC_MOVER_A1
Skip back to 2a1. SC_STAY
Skip back to 2a3. SC_PREVPRXY

Skip to SC_REASON

Skip to SC_OUTCOME

Skip to CONTINUATION CHECK

Skip to INTRO A in the Control Card

Skip to IADL_WHO1 in Control Card
 Skip to DT INTRO in the Control Card
 Skip back to 1a1. SC_MOVER_A1
 Skip back to 2a1. SC_STAY
 Skip back to 2a3. SC_PREVPRXY

IADL Module

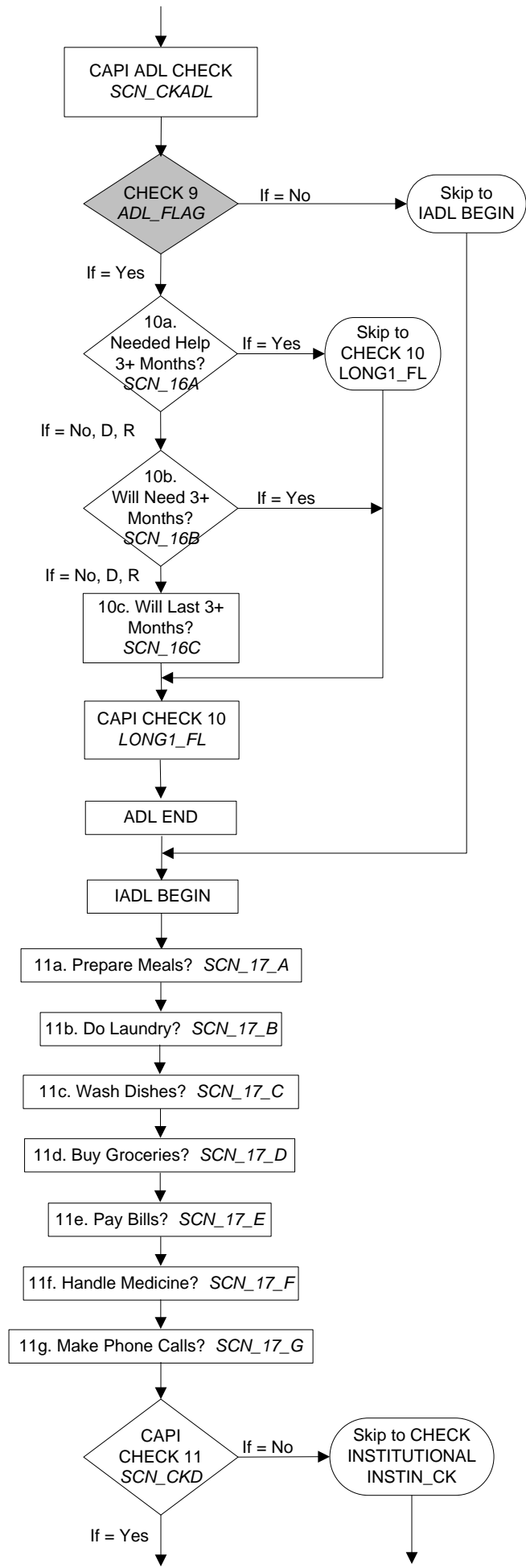

Skip to SC_REASON
 Skip to SC_OUTCOME
 Skip to CONTINUATION CHECK
 Skip to INTRO A in the Control Card

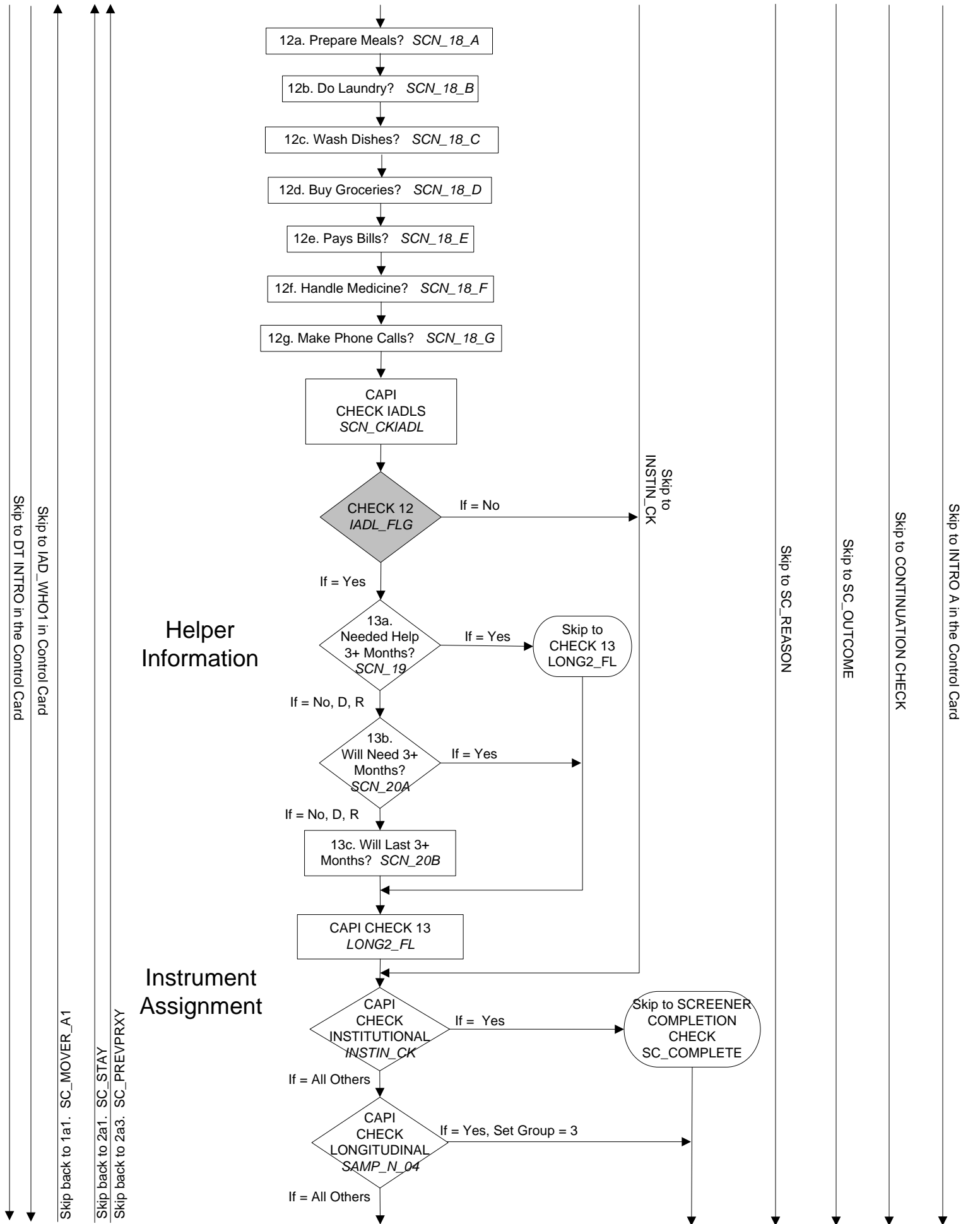

Helper Information

Instrument Assignment

